

B15 Kopierfräser 90°/91° *Copy mills, Fraises à copier 90°, Frese per profilatura*

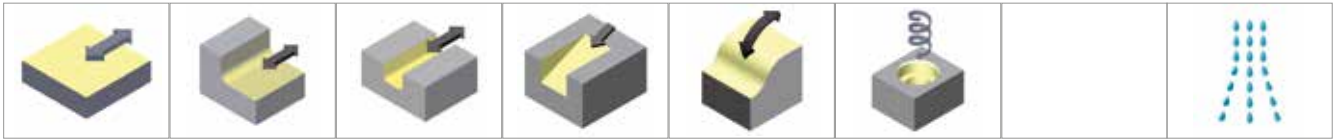

Aufsteckfräser *Shell type mills, Fraises à alésage, Frese per attacco a manicotto*

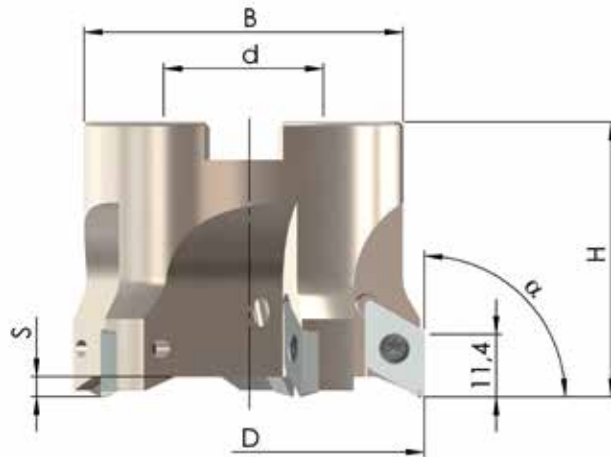

Bestell-Nr. <i>Order-No., Référence, Codice</i>	α	D	H	d	B	S	Z	MS
90PP-052-422-4	90°	52	50	22	46	3,7	4	MS-10x30-912
90PP-066-422-5	90°	66	50	27	58	3,7	5	MS-12x30-912
90PP-080-422-6	90°	80	50	27	58	3,7	6	MS-12x30-912

Bestell-Nr. <i>Order-No., Référence, Codice</i>	α	D	H	d	B	S	Z	MS
91PP-052-422-4	91°	52	50	22	46	3,7	4	MS-10x30-912
91PP-066-422-5	91°	66	50	27	58	3,7	5	MS-12x30-912
91PP-080-422-6	91°	80	50	27	58	3,7	6	MS-12x30-912

MS= Mittenschraube *Central screw, Vis centrale, Vite centrale di fissaggio*

B15 Kopierfräser 90°/91° *Copy mills, Fraises à copier 90°, Frese per profilatura*

Einschraubfräser *Screw-In cutters, Fraises à queue fileté, Frese con attacco filettato*

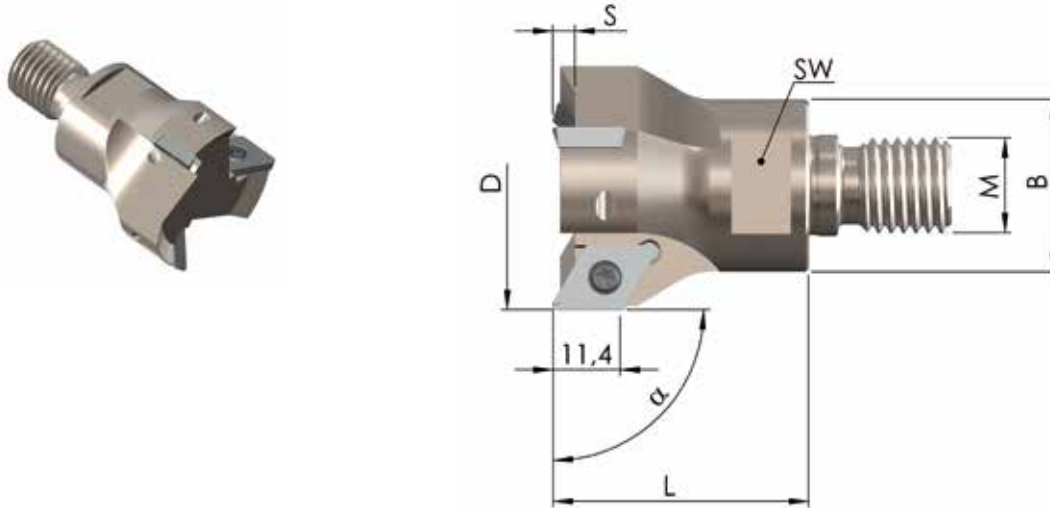











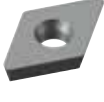

Bestell-Nr. <i>Order-No., Référence, Codice</i>	α	D	L	M	B	SW	S	Z
90ESF-25-M12-422-2	90°	25	35	M12	21	18	3,7	2
90ESF-35-M16-422-3	90°	35	43	M16	29	24	3,7	3
90ESF-42-M16-422-3	90°	42	43	M16	29	24	3,7	3
90ESF-42-M16-422-4	90°	42	43	M16	29	24	3,7	4

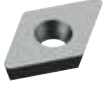
Bestell-Nr. <i>Order-No., Référence, Codice</i>	α	D	L	M	B	SW	S	Z
91ESF-25-M12-422-2	91°	25	35	M12	21	18	3,7	2
91ESF-35-M16-422-3	91°	35	43	M16	29	24	3,7	3
91ESF-42-M16-422-3	91°	42	43	M16	29	24	3,7	3

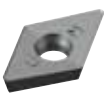
B15 Fräswendeplatten und Schnittdaten

Milling inserts and parameters, Plaquettes de fraisage et paramètres, Inserti e parametri di taglio

			HT50 (code 22)	KT05 (code 28)	K15M (code 8)	AL20 (code 24)			
									
	JMB15-422R10- 11,0x11,0x3,5 R1,0	Order- No.	B15A-JM22						
	 	f _z [mm]	0,25 (0,10-0,30)						
	JMB15-424R10- 11,0x11,0x3,5 R1,0	Order- No.		B15B-KX28					
	 	f _z [mm]		0,10 (0,05-0,25)					
	JMB15-426R08- 11,0x11,0x3,5 R0,8	Order- No.			B15D-UT08	B15D-MP24			
	 	f _z [mm]			0,30 (0,10-0,50)	0,30 (0,10-0,50)			
			10	10	10	10			

V _c [m/min]	Stahl Steel Acier Acciaio	Rostfrei Stainless Acier inoxydable Inossidabile	Guss Cast iron Fonte Ghisa	NE-Metalle Non-ferrous metals Non ferreux Metalli non ferrosi	Hochwarmfest Highly heat-resistant Superalliages Resistente al calore	Gehärtet Tempered Aciers traités Temprato
HT50	220 (160 - 300)	200 (100 - 300)	260 (200 - 300)			
KT05						120 (80 - 250)
K15M				400 (300 - 600)		
AL20				600 (500 - 1000)		

Ersatzteile Spare parts, Pièces de rechange, Parti di ricambio

	SS 4,0-1 (M = 3,2 - 3,3 Nm)		T 15		Fett Grease, Graisse, Grasso
---	---------------------------------------	---	-------------	---	--