

## B11 Trägerkörper für die Aluminiumbearbeitung

Cassette holders for aluminium working, Fraise à cassettes pour l'usinage de l'aluminium, Supporti per porta inserti per la lavorazione di alluminio

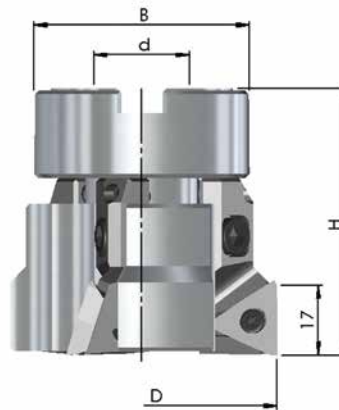

**Aufsteckfräser** Shell type mills, Fraises à alésage, Frese con attacco a manicotto



Bestell-Nr. <i>Order-No., Référence, Codice</i>	D	H	d	B	Z	MS
TKA-068-3-AL-B	68	68	22	54,0	3	MS-10x50-912
TKA-080-3-AL-B	80	68	27	66,0	3	MS-12x50-912
TKA-100-4-AL-B	100	68	32	85,5	4	MS-16x50-912
TKA-125-4-AL-B	125	75	40	111,0	4	MS-20x45-7991
TKA-160-5-AL-B	160	75	40	146,0	5	MS-20x45-7991











MS= Mittenschraube Central screw, Vis centrale, Vite centrale di fissaggio

**Kassetten** Cassettes, Cassettes, Porta inserti

	<b>K90-83-G</b>	<p><b>NI-beschichtete, hoch verschleißfeste Ausführung</b>  <i>Hard wearing NI-Coating</i>  <i>Série à revêtement anti-usure NI</i>  <i>Modello con rivestimento NI resistente all'usura</i></p>
--	-----------------	--

## B11 Fräswendeplatten und Schnittdaten

Milling inserts and parameters, Plaquettes de fraisage et paramètres, Inserti e parametri di taglio

			<b>K15M</b> (code 8) 	<b>AL10</b> (code 10) 	<b>KD16</b> (code 16) 	<b>PKD</b> (code 43) 			
	<b>JMB11-83-</b> IK 12,7x3,97  	Order-No.	<b>B11B-DH08</b>	<b>B11B-CW10</b>	<b>B11B-EU16</b>	<b>B11B-FL43</b>			
	$f_z$ [mm]		0,30 (0,20-0,60)	0,30 (0,20-0,60)	0,30 (0,20-0,60)	0,30 (0,20-0,60)			
	<b>JMB11-83R08-</b> IK 12,7x3,97 R0,8  	Order-No.		<b>B11B-GM10</b>					
	$f_z$ [mm]			0,30 (0,20-0,60)					
			10	10	5	5			

$V_c$ [m/min]	<b>Stahl</b> Steel Acier Acciaio	<b>Rostfrei</b> Stainless Acier inoxydable Inossidabile	<b>Guss</b> Cast iron Fonte Ghisa	<b>NE-Metalle</b> Non-ferrous metals Non ferreux Metalli non ferrosi	<b>Hochwarmfest</b> Highly heat-resistant Superaliages Resistente al calore	<b>Gehärtet</b> Tempered Aciers traités Temprato
<b>K15M</b>				400 (300 - 600)		
<b>AL10</b>				600 (500 - 1000)		
<b>KD16</b>				600 (500 - 1000)		
<b>PKD</b>				1000 (500 - 2000)		

### Ersatzteile Spare parts, Pièces de rechange, Parti di ricambio

	<b>SS 5,0-3</b> (M = 4,8-5,0 Nm)		<b>T 20</b>		<b>Fett</b> Grease, Graisse, Grasso
---	-------------------------------------	---	-------------	---	--