

B09 Vorwärtssenker *Counterboring mills, Fraises à lamer, Frese per lamatura*

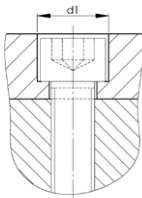

DIN 974 T1 Reihe 1
(DIN 74 Form H, J, K)



DIN 974 T1 Reihe 5

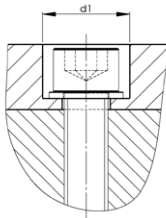

DIN 974 T2 Reihe 3
(DIN 74 Form R)

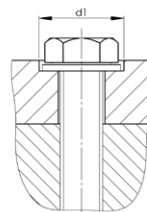

DIN 974 T2 Reihe 1+2
(DIN 74 Form SA, TA, SB, TB)

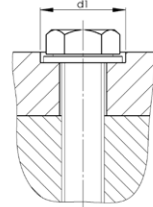

Schafffräser DIN 1835-B *Shank type mills, Fraises à queue Weldon, Frese a gambo Weldon*

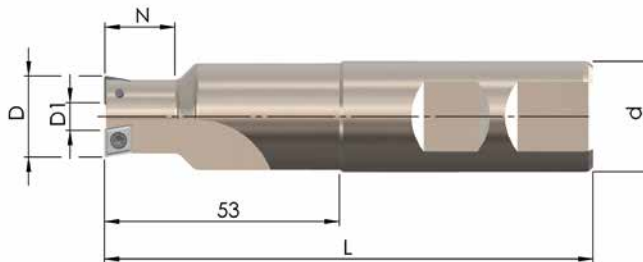

Bestell-Nr.	D	für Gewinde \emptyset for thread \emptyset , pour filetage \emptyset , per filettatura \emptyset					L	d	D ₁	N	Z
Order-No., Référence, Codice		T1/1 (Form H,J,K)	T1/5	T2/1 (Form SA,TA)	T2/2 (Form SB,TB)	T2/3 (Form R)					
VS 90-M6-65	11	M 6	-	M 3	M 3	M 5	110	25	1,7	9,0	1
VS 90-M8-65	15	M 8	M 6	M 5	M 4	-	110	25	2,3	15,0	1
VS 90-M10-65	18	M10	M 8	M 6	M 5	M 8	110	25	5,3	16,5	2

B09 T-Nutenfräser *T-Slot milling cutters, Fraises à rainurer en T, Fresa per scanalature a "T"*

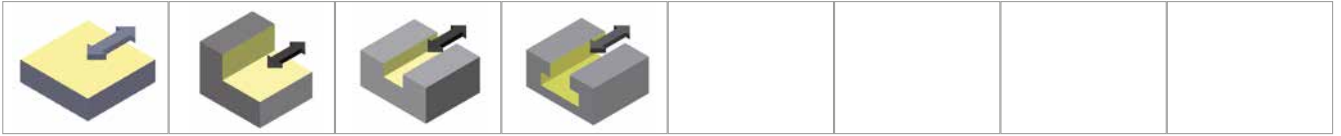



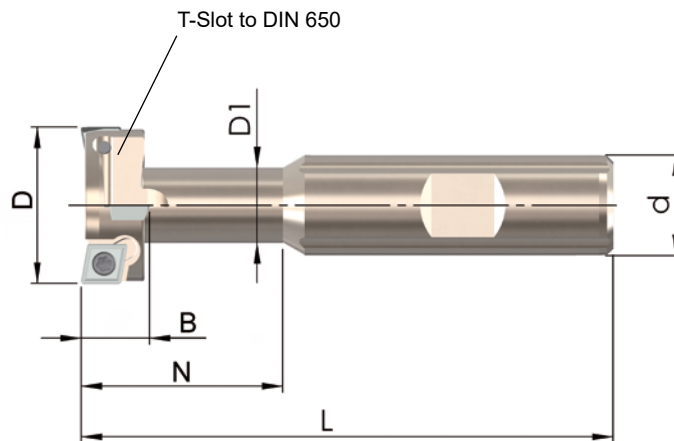

Schafffräser DIN 1835-B *Shank type mills, Fraises à queue Weldon, Frese a gambo Weldon*



Bestell-Nr. <i>Order-No., Référence, Codice</i>	D	D1	B	L	N	d	Z	ZZ
90TN-21-09-65-2	21	11	9,0	85	32	16	2	4
90TN-25-11-65-2	25	12	11,0	85	32	16	2	4





B09 Fräswendeplatten und Schnittdaten

Milling inserts and parameters, Plaquettes de fraisage et paramètres, Inserti e parametri di taglio

			HT50 (code 22)	Ti20 (code 1)				
	JMB09-65R04- 6,35x6,35x2,36 R0,4	Order- No.	B09A-LB22	B09A-NC01				
		f _z [mm]	0,10 (0,05-0,20)	0,10 (0,05-0,20)				
			20	20				

V _c [m/min]	Stahl Steel Acier Acciaio	Rostfrei Stainless Acier inoxydable Inossidabile	Guss Cast iron Fonte Ghisa	NE-Metalle Non-ferrous metals Non ferreux Metalli non ferrosi	Hochwarmfest Highly heat-resistant Superalliages Resistente al calore	Gehärtet Tempered Aciers traités Temprato
HT50	220 (160 - 300)	200 (100 - 300)	260 (200 - 300)			
Ti20	250 (220 - 280)	220 (180 - 300)	260 (180 - 350)			

Ersatzteile Spare parts, Pièces de rechange, Parti di ricambio

	SS 2,5-1 ø18 (M = 1,2-1,3 Nm)		T 08		Fett Grease, Graisse, Grasso
	SS 2,5-2 ø11+15 (M = 1,2-1,3 Nm)				