

B14 Kopierfräser 90° / 91°

Copy mills, Fraises à copier 90°, Frese per profilatura

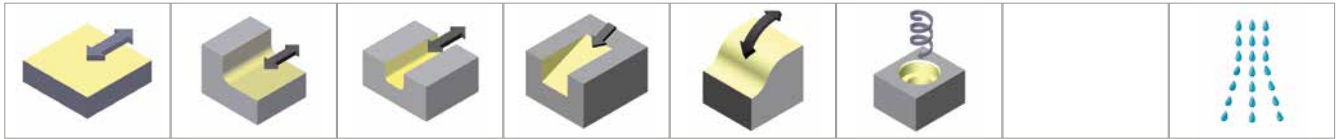

Einschraubfräser Screw-In cutters, Fraises à queue fileté, Frese con attacco filettato

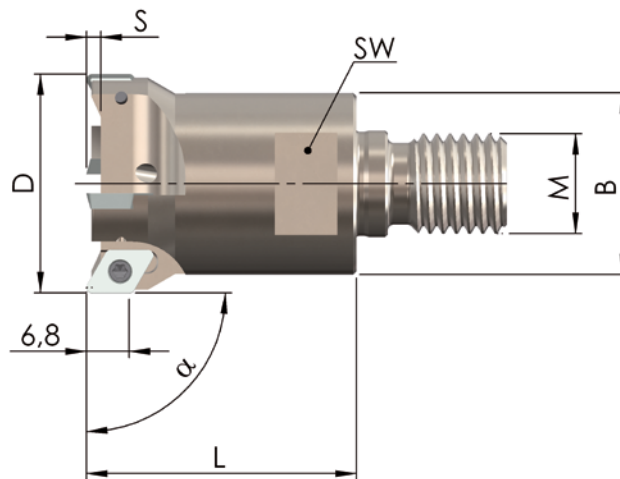

















Bestell-Nr. <i>Order-No., Référence, Codice</i>	α	D	L	M	B	SW	S	Z
90ESF-15-M8-421-2	90°	15	23	M 8	13,8	12	2,1	2
90ESF-16-M8-421-2	90°	16	23	M 8	13,8	12	2,3	2
90ESF-20-M10-421-3	90°	20	30	M10	18,0	16	2,3	3
90ESF-25-M12-421-3	90°	25	35	M12	21,0	18	2,3	3
90ESF-35-M16-421-4	90°	35	43	M16	29,0	24	2,3	4
90ESF-42-M16-421-5	90°	42	43	M16	29,0	24	2,3	5

Bestell-Nr. <i>Order-No., Référence, Codice</i>	α	D	L	M	B	SW	S	Z
91ESF-16-M8-421-2	91°	16	23	M 8	13,8	12	2,3	2
91ESF-20-M10-421-3	91°	20	30	M10	18,0	16	2,3	3
91ESF-25-M12-421-3	91°	25	35	M12	21,0	18	2,3	3
91ESF-35-M16-421-4	91°	35	43	M16	29,0	24	2,3	4
91ESF-42-M16-421-5	91°	42	43	M16	29,0	24	2,3	5

B14 Fräswendeplatten und Schnittdaten

Milling inserts and parameters, Plaquettes de fraisage et paramètres, Inserti e parametri di taglio

			HT50 (code 22)	KT05 (code 28)	K15M (code 8)	AL20 (code 24)			
									
	JMB14-421R10- 7,0x7,0x2,5 R1,0	Order- No. B14A-HO22							
		f_z [mm]	0,20 (0,10-0,30)						
	JMB14-423R10- 7,0x7,0x2,5 R1,0	Order- No. B14B-MG28							
		f_z [mm]		0,10 (0,05-0,25)					
	JMB14-425R04- 7,0x7,0x2,5 R0,4	Order- No. B14D-PH08							
		f_z [mm]			0,25 (0,10-0,40)				
	JMB14-425R08- 7,0x7,0x2,5 R0,8	Order- No. B14D-YH08 B14D-SL24							
		f_z [mm]			0,25 (0,10-0,40)	0,25 (0,10-0,40)			
			20	20	20	20			

V_c [m/min]	Stahl Steel Acier Acciaio	Rostfrei Stainless Acier inoxydable Inossidabile	Guss Cast iron Fonte Ghisa	NE-Metalle Non-ferrous metals Non ferreux Metalli non ferrosi	Hochwarmfest Highly heat-resistant Superalliages Resistente al calore	Gehärtet Tempered Aciers traités Temprato
HT50	220 (160 - 300)	200 (100 - 300)	260 (200 - 300)			
KT05						120 (80 - 250)
K15M				400 (300 - 600)		
AL20				600 (500 - 1000)		

Ersatzteile Spare parts, Pièces de rechange, Parti di ricambio

	SS 2,5-1 (M = 1,2 - 1,3 Nm)		T 08		Fett Grease, Graisse, Grasso
---	---------------------------------------	---	-------------	---	--