

A09 Planfräser *Face mills, Fraises à surfacer, Frese a spianare*

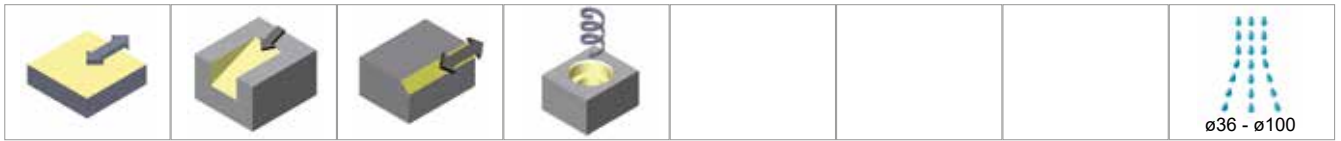

Aufsteckfräser *Shell type mills, Fraises à alésage, Frese per attacco a manicotto*

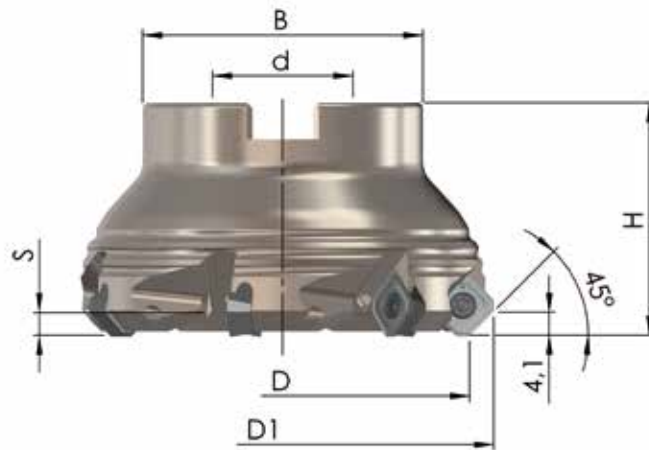

Bestell-Nr. <i>Order-No., Référence, Codice</i>	D	D ₁	H	d	B	S	Z	MS
45PP-036-329-5	36	44,6	40	16	38	4	5	MS-8x20-912
45PP-040-329-16-5	40	48,6	40	16	46	4	5	MS-8x20-912
45PP-040-329-22-5	40	48,6	40	22	46	4	5	MS-10x25-912
45PP-050-329-6	50	58,6	40	22	46	4	6	MS-10x25-912
45PP-063-329-7	63	71,6	40	22	46	4	7	MS-10x25-912
45PP-080-329-8	80	88,6	50	27	58	4	8	MS-12x30-912
45PP-100-329-9	100	108,6	50	32	78	4	9	MS-16x30-912
45PP-125-329-10	125	133,6	50	40	90	4	10	MS-20x45-7991

MS= Mittenschraube *Central screw, Vis centrale, Vite centrale di fissaggio*



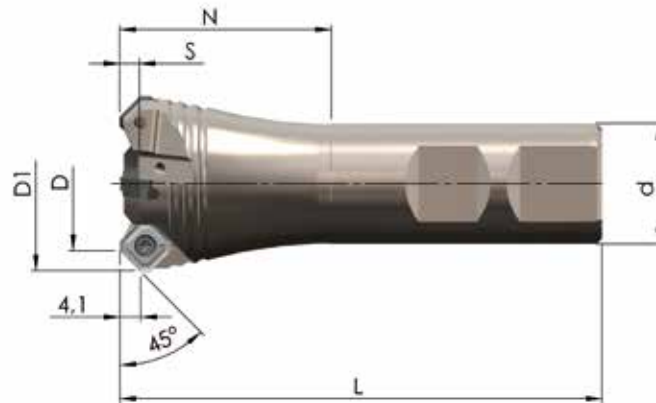







Schafffräser DIN 1835-B *Shank type mills, Fraises à queue Weldon, Frese a gambo Weldon*



Bestell-Nr. Order-No., Référence, Codice	D	D1	N	L	d	S	Z
45PP-22-329	22	30,6	44	100	25	4	3
45PP-25-329	25	33,6	44	100	25	4	3
45PP-28-329	28	36,6	44	100	25	4	4
45PP-32-329	32	40,6	44	100	25	4	4

A09 Fräswendepplatten und Schnittdaten

Milling inserts and parameters, Plaquettes de fraisage et paramètres, Inserti e parametri di taglio

			HT45 (code 31)	HT50 (code 22)	HT32 (code 33)	HT35 (code 19)	HT20 (code 32)	K15M (code 8)	
	JMA09-329- 9,00x9,00x3,97	Order- No.	A09A-BL31	A09A-DM22	A09A-AK33				
U 	f_z [mm]		0,20 (0,10-0,30)	0,20 (0,10-0,30)	0,20 (0,10-0,30)				
	JMA09-331- 9,00x9,00x3,97	Order- No.		A09A-EN22					
U 	f_z [mm]			0,20 (0,10-0,30)					
	JMA09-349- 9,00x9,00x3,97	Order- No.					A09A-FR32		
M H 	f_z [mm]						0,20 (0,10-0,30)		
	JMA09-339- 9,00x9,00x3,97	Order- No.	A09B-DP31			A09B-CO19			
S 	f_z [mm]		0,20 (0,10-0,30)			0,20 (0,10-0,30)			
	JMA09-339- 9,00x9,00x3,97	Order- No.						A09D-ES08	
U 	f_z [mm]							0,20 (0,10-0,30)	
			20	20	20	20	20	20	

V_c [m/min]	Stahl Steel Acier Acciaio	Rostfrei Stainless Acier inoxydable Inossidabile	Guss Cast iron Fonte Ghisa	NE-Metalle Non-ferrous metals Non ferreux Metalli non ferritici	Hochwarmfest Highly heat-resistant Superalliages Resistente al calore	Gehärtet Tempered Aciers traités Temprato
HT45	250 (200 - 350)	240 (140 - 300)	240 (130 - 280)			
HT50	220 (160 - 300)	200 (100 - 300)	260 (200 - 300)			
HT32	250 (200 - 350)	240 (140 - 300)			60 (40 - 200)	
HT35	160 (120 - 220)	200 (100 - 300)			60 (40 - 200)	
HT20			260 (180 - 350)			80 (40 - 120)
K15M				400 (300 - 600)		

Ersatzteile Spare parts, Pièces de rechange, Parti di ricambio

	SS 3,0-2 (M = 1,7-1,8 Nm)		T 09		Fett Grease, Graisse, Grasso
---	-------------------------------------	---	-------------	---	--